

SW 1.4/25-28

Specifications

Part Number	S280625	HH'	35.556mm
Focal Length	25mm	Mount	M42
Image Circle	28mm	MaxD	Φ58
Max. F#	F1.4	Filter	M56.5×0.5
Magnification	0.0-0.25	Σd	81.90mm
Spectrum	900-1700nm	A'	5.07mm-11.31mm
Working Distance	93mm-∞	A'f	16.06mm-22.3mm
Resolution	3.45 μm		

Mechanical Drawing

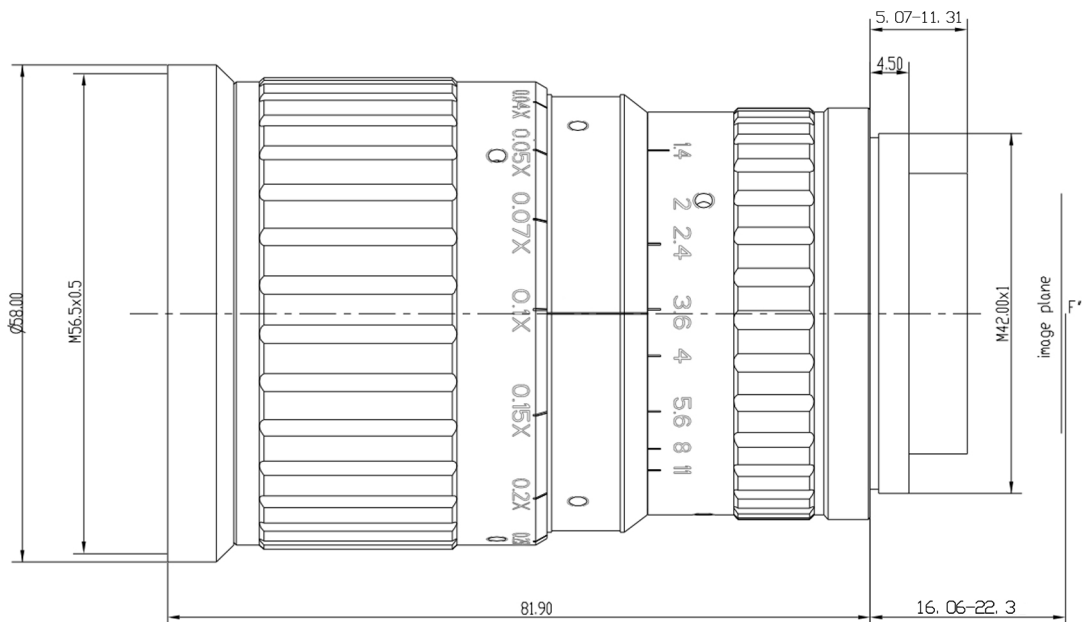

Distortion

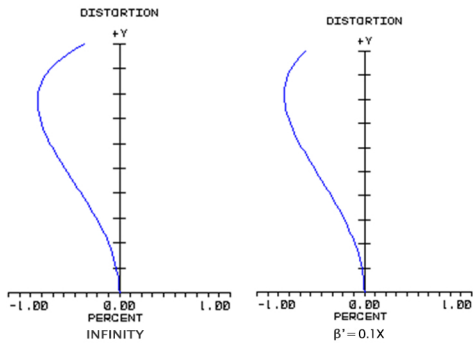

Field Curvature

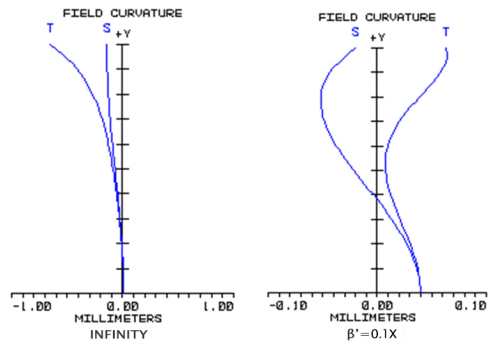

Modulation to Relative Image Height

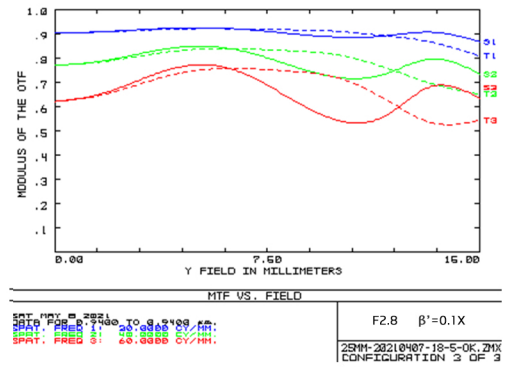
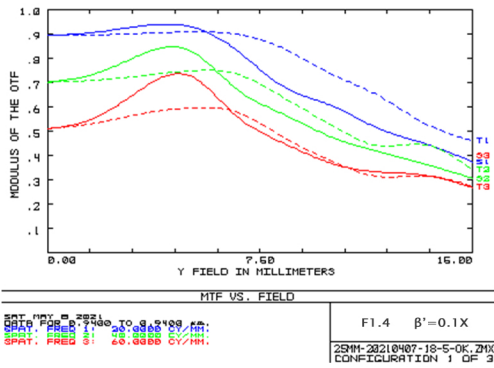

Relative Illumination

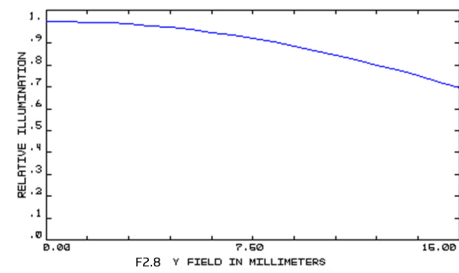
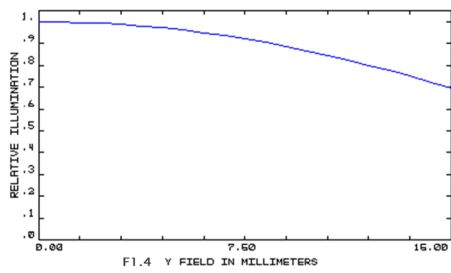

Transmittance

